

nood[®]

107813

Montemart 2 Seat Sofa

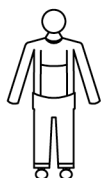

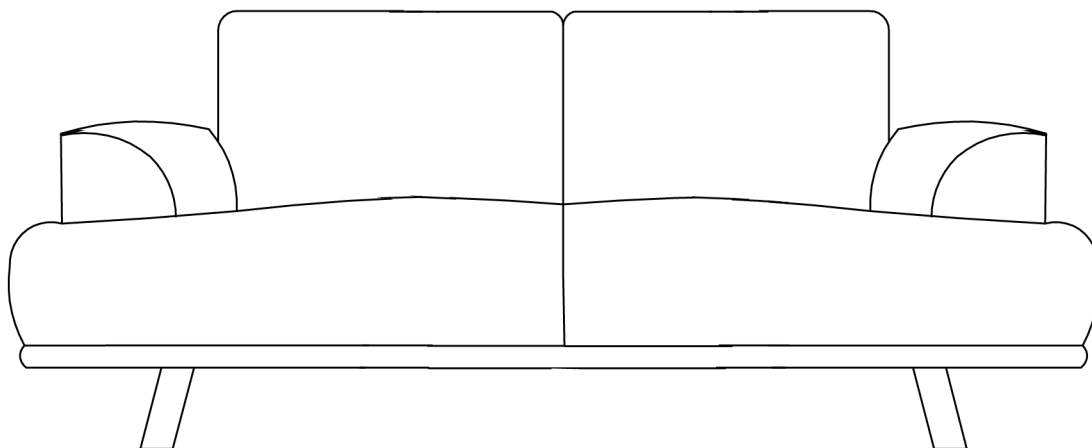
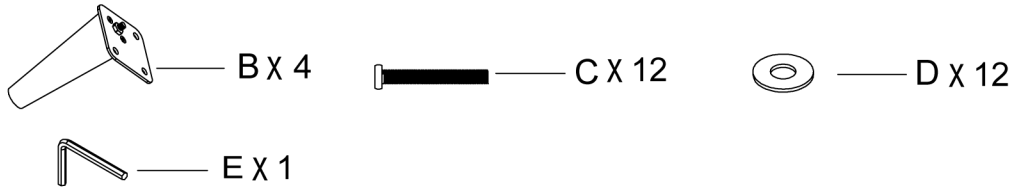
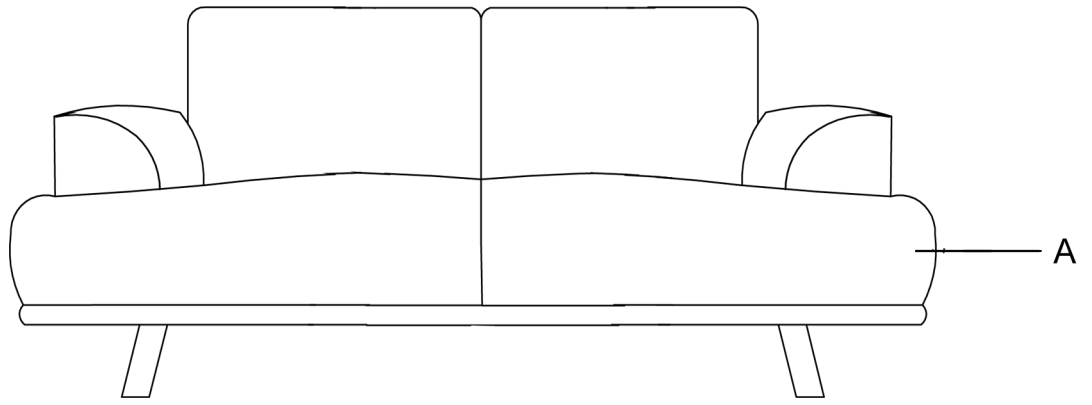

1

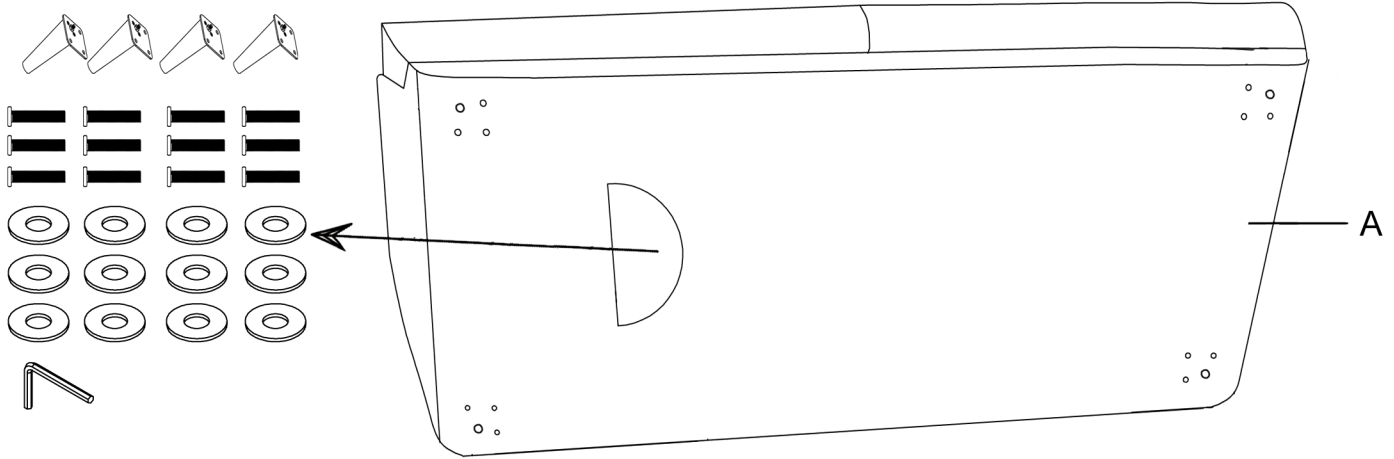

2

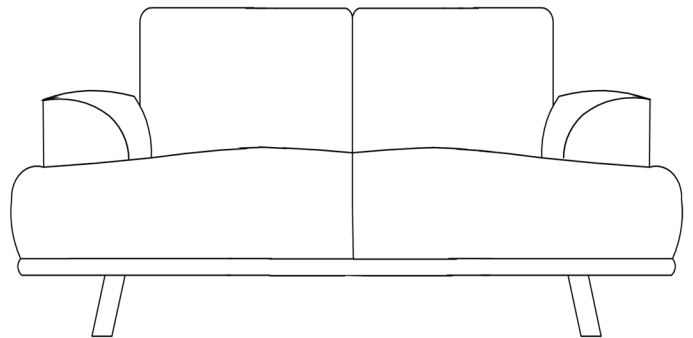
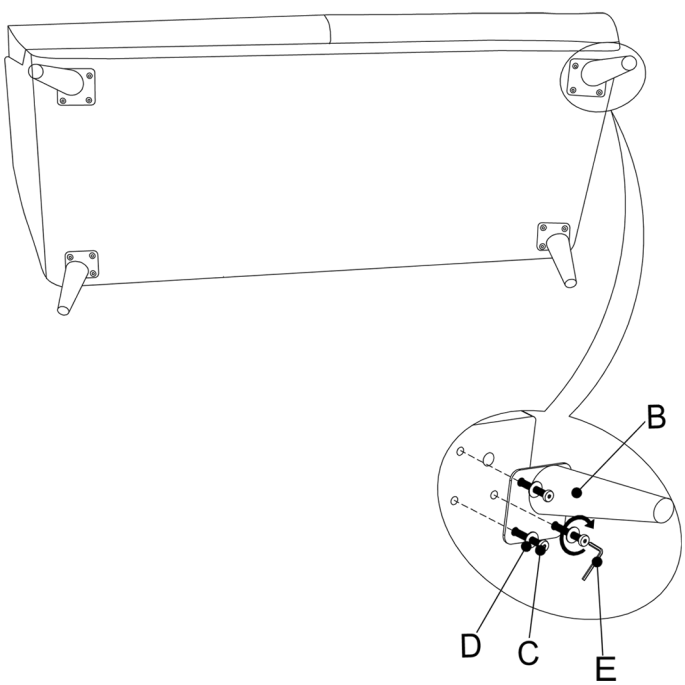

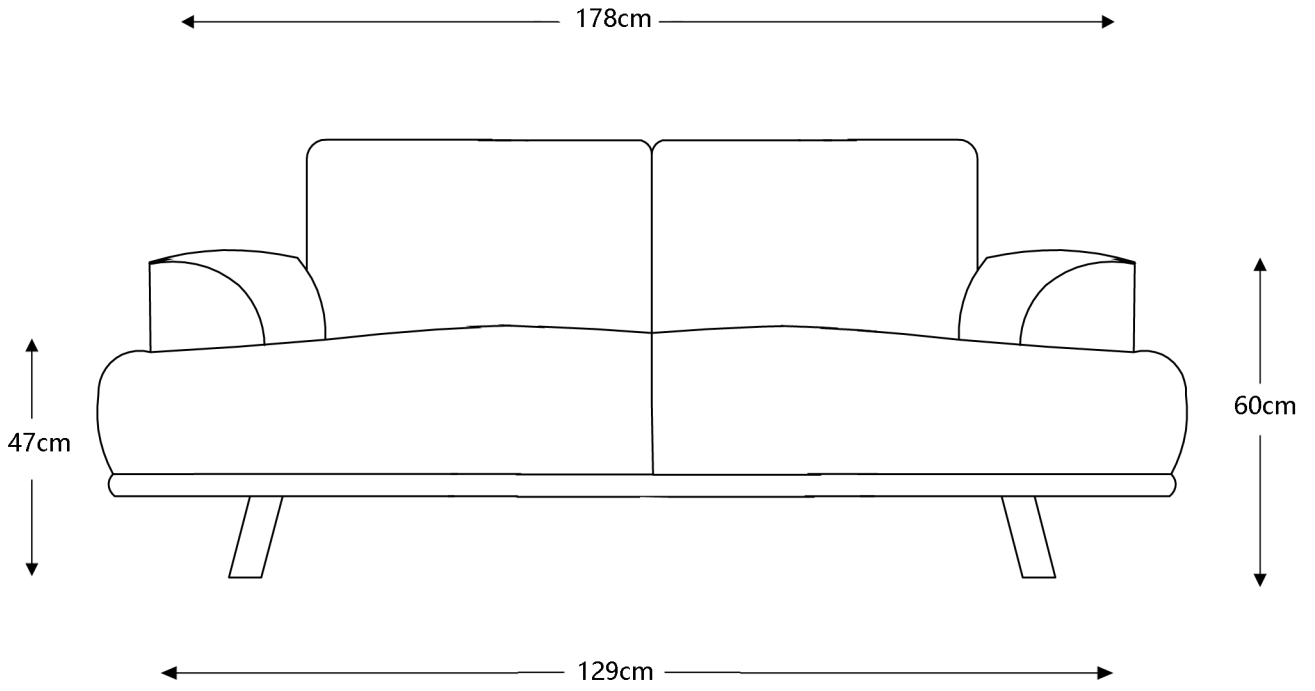

care and cleaning advice

fabric furniture

we hope you love your new purchase for many years to come. in order to care and maintain your new furniture, please note the following advice:

- protect from direct sunlight, direct heat and weather. all fabrics can fade over time depending on their exposure to sunlight. all natural fibre fabrics have a tendency to fade more easily, while synthetic fabrics are more hard wearing and colour fast.
- periodically clean your furniture with a soft brush or using a low suction vacuum cleaner.
- it is normal for some fabrics to pill after initial use. to remove the pills and prevent further pilling please de-pill the fabrics using a fabric stone or lint shaver.
- blot any food or liquid spills immediately with a dry, white clean cloth. do not use abrasive or harsh chemical cleaners on the fabric. do not rub.
- spot cleaning can be done with an upholstery cleaner, but always test the product and fabric first in an inconspicuous area.
- if the entire piece requires cleaning professional upholstery cleaning, is recommended.
- feather-filled seat cushions and back cushions are designed to be natural, soft and luxurious. they will shift and settle with normal everyday use, gently fluff and re-position the feathers to return the cushions to their original soft shape.
- sit back, relax and enjoy your new purchase!

