

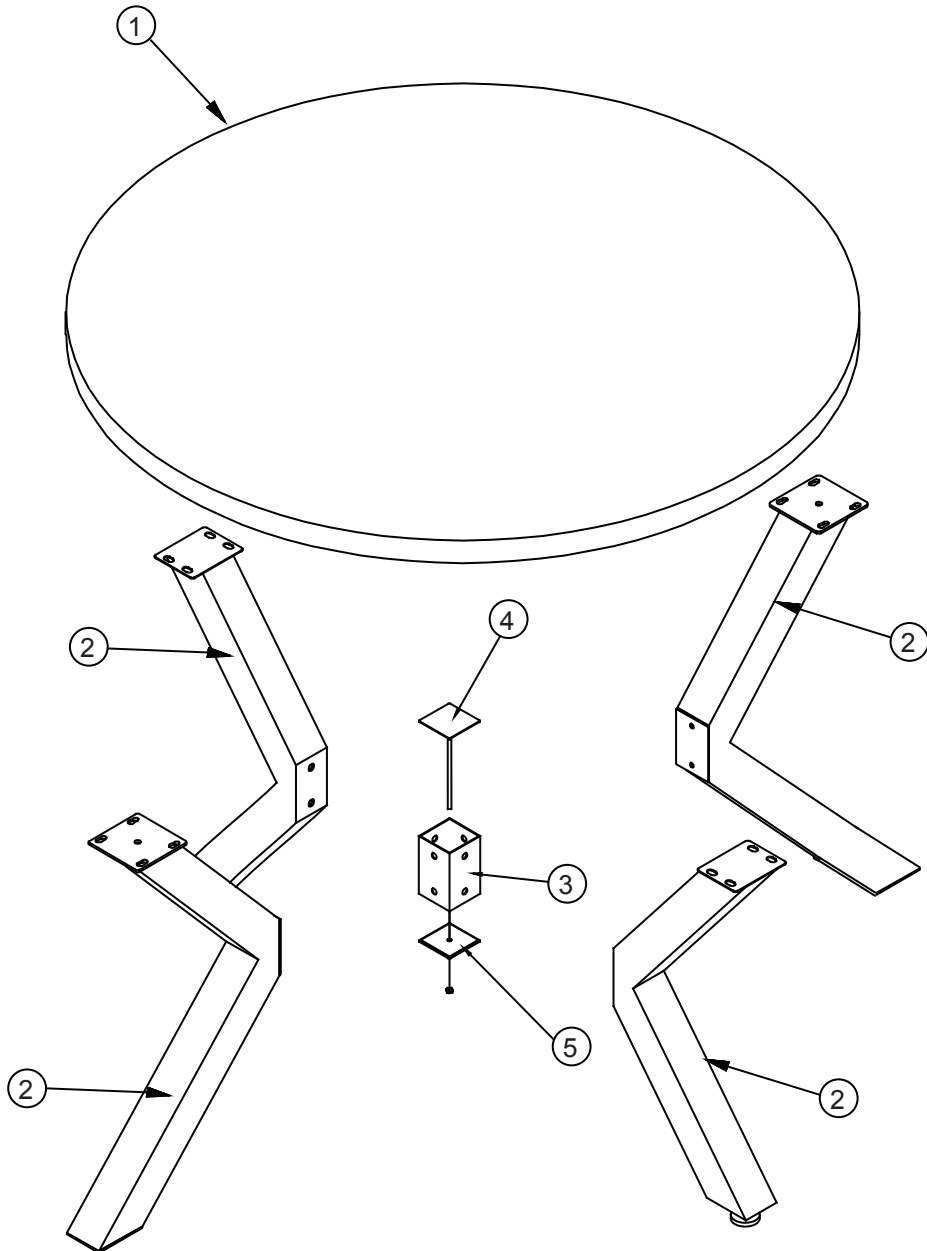









①	1	Ø1200x37	
②	4	705x386x100	
③	1	60x60x132	
④	1	59x59x122	
⑤	1	59x59x3	

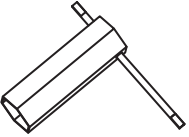

<p>Ax16</p>  <p>M8 x25 mm</p>	<p>Bx25</p>  <p>Ø8/Ø16 mm</p>	<p>Cx8</p>  <p>M8x10 mm</p>	<p>Dx1</p>  <p>M8/14 mm</p>	<p>Ex4</p>  <p>Ø50/M8x16 mm</p>
<p>Fx1</p>  <p>M8x48 mm</p>	<p>Gx1</p>  <p>5 mm</p>			

1

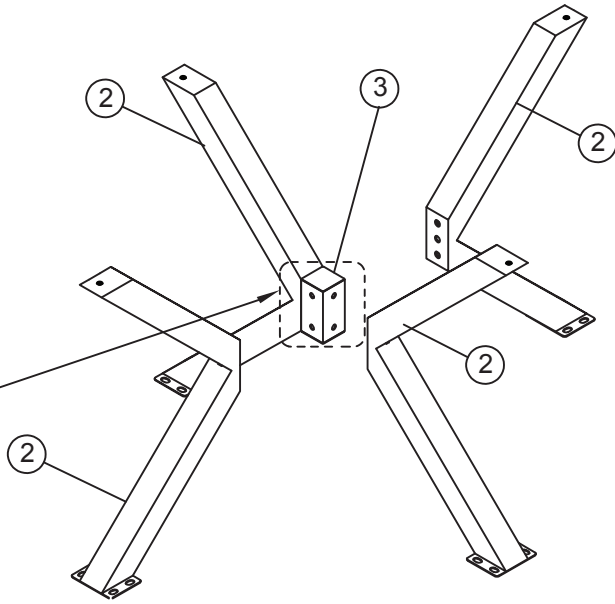
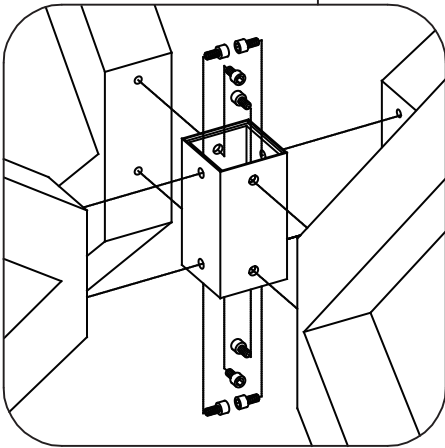
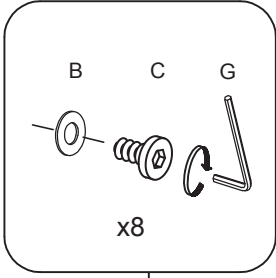

Bx8  Ø8/Ø16 mm	Cx8  M8x10 mm	Gx1  5 mm
---	--	--

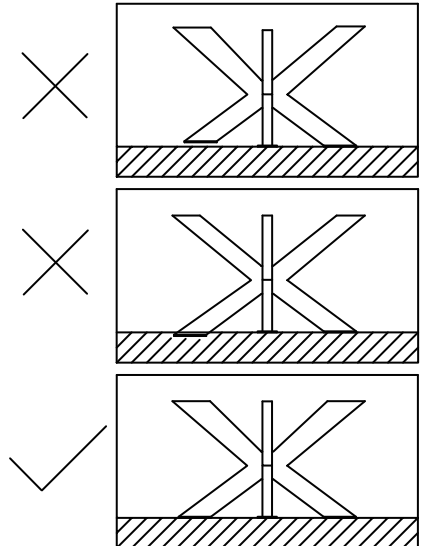
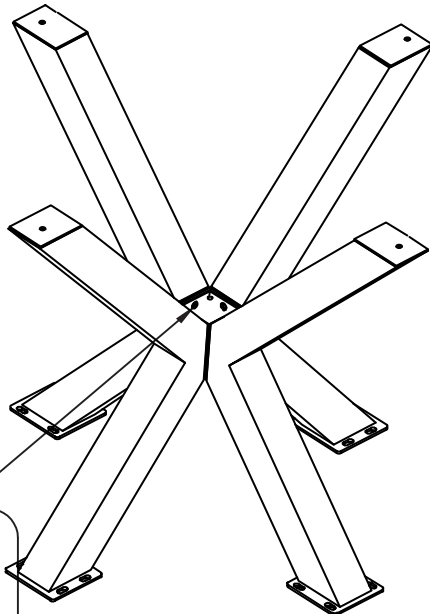
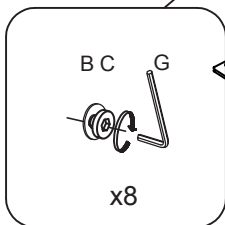

2



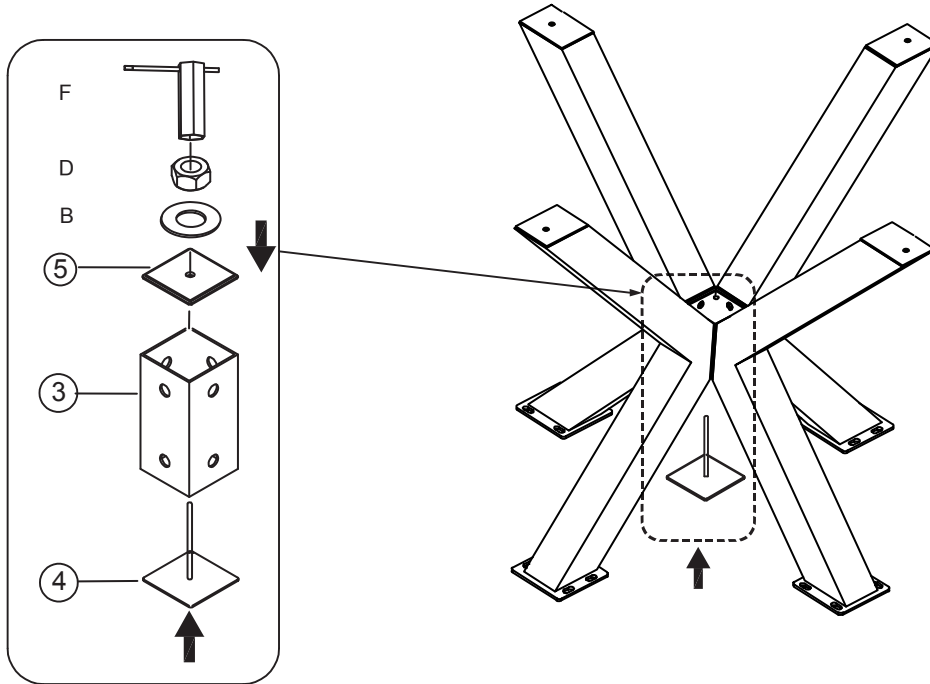

3

Bx1  Ø8/Ø16 mm	Dx1  M8/14 mm	Fx1  M8x48 mm
---	--	--



4

Ax16  M8x25 mm	Bx16  Ø8/Ø16 mm	Gx1  5 mm
---	--	--

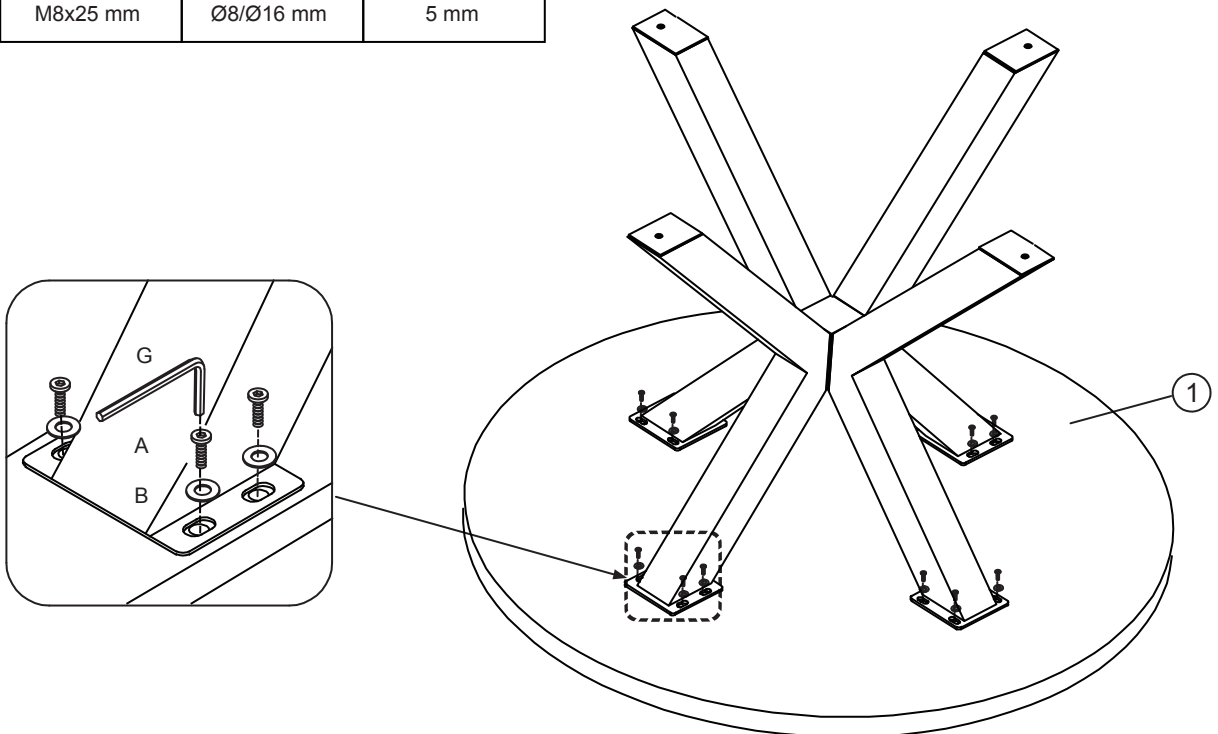

5

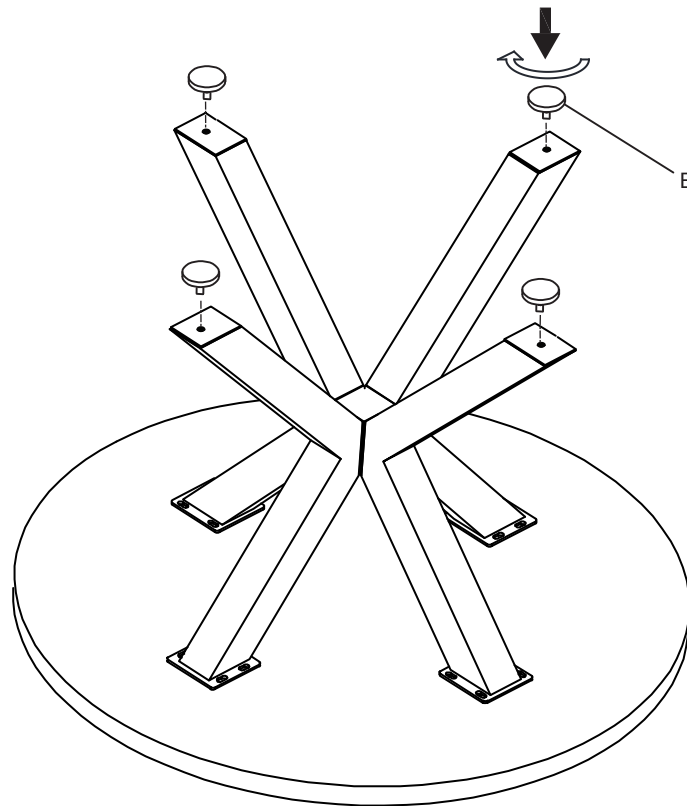
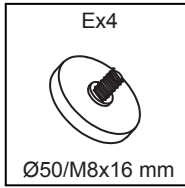

6

