

nood

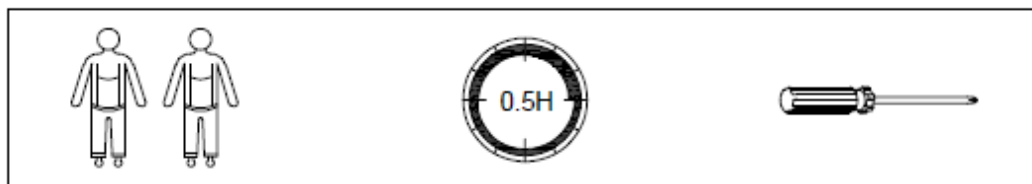

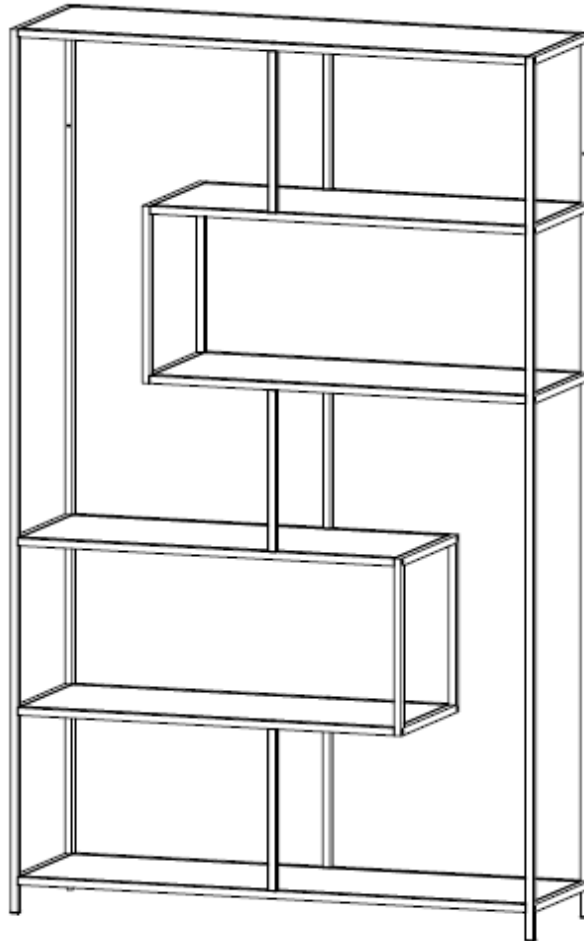





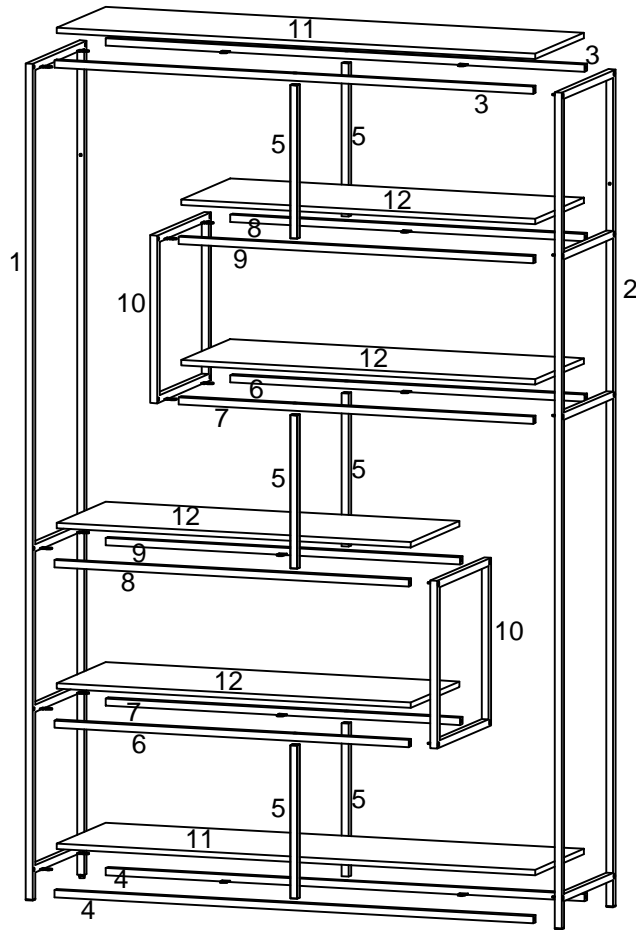





108004

Eliot

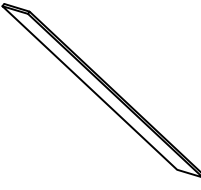

1/10



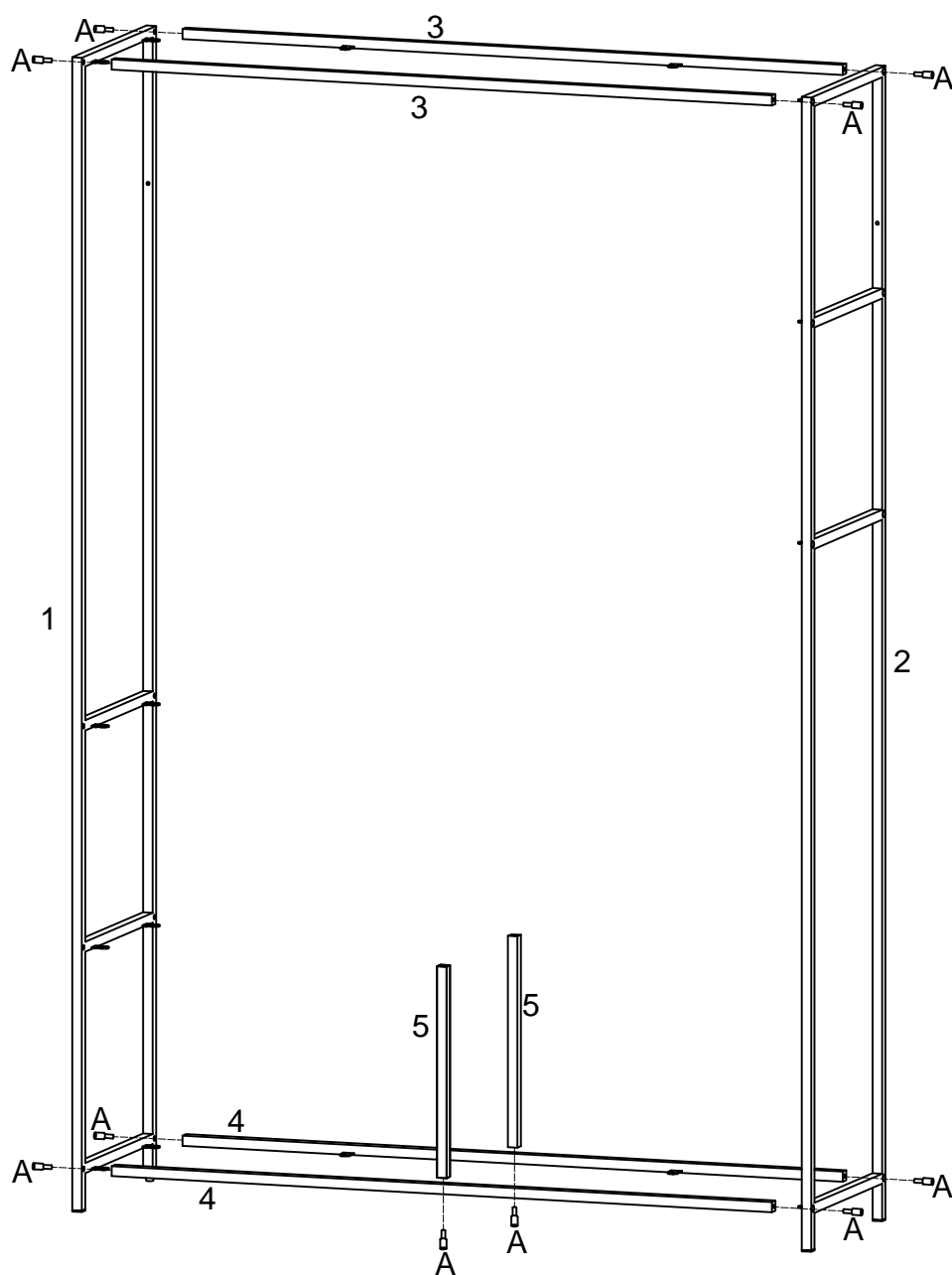
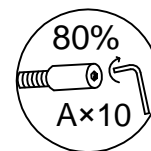

| | | | | | |
|--|--|--|---|---|---|
| 1  1PC | 2  1PC | 3  2PCS | 4  2PCS | 5  6PCS | 6  2PCS |
| 7  2PCS | 8  2PCS | 9  2PCS | 10  2PCS | 11  2PCS | 12  4PCS |
| A M6×15mm  36PCS | B M4×10mm  40PCS | C 4mm  1PC | | | |



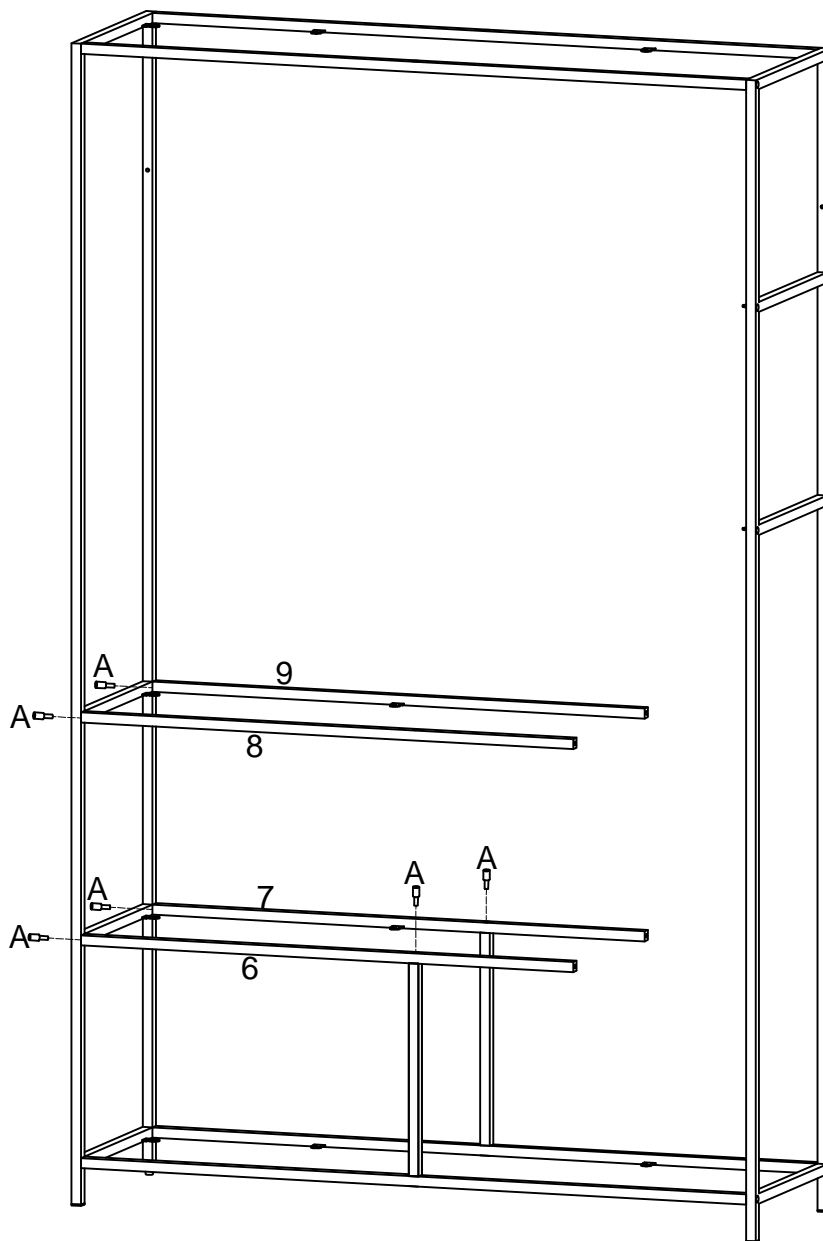
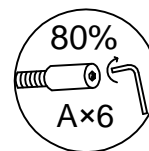

| | |
|----------------------------------|----------------------------|
| A M6×15mm 10PCS | C 4mm 1PC |
|----------------------------------|----------------------------|



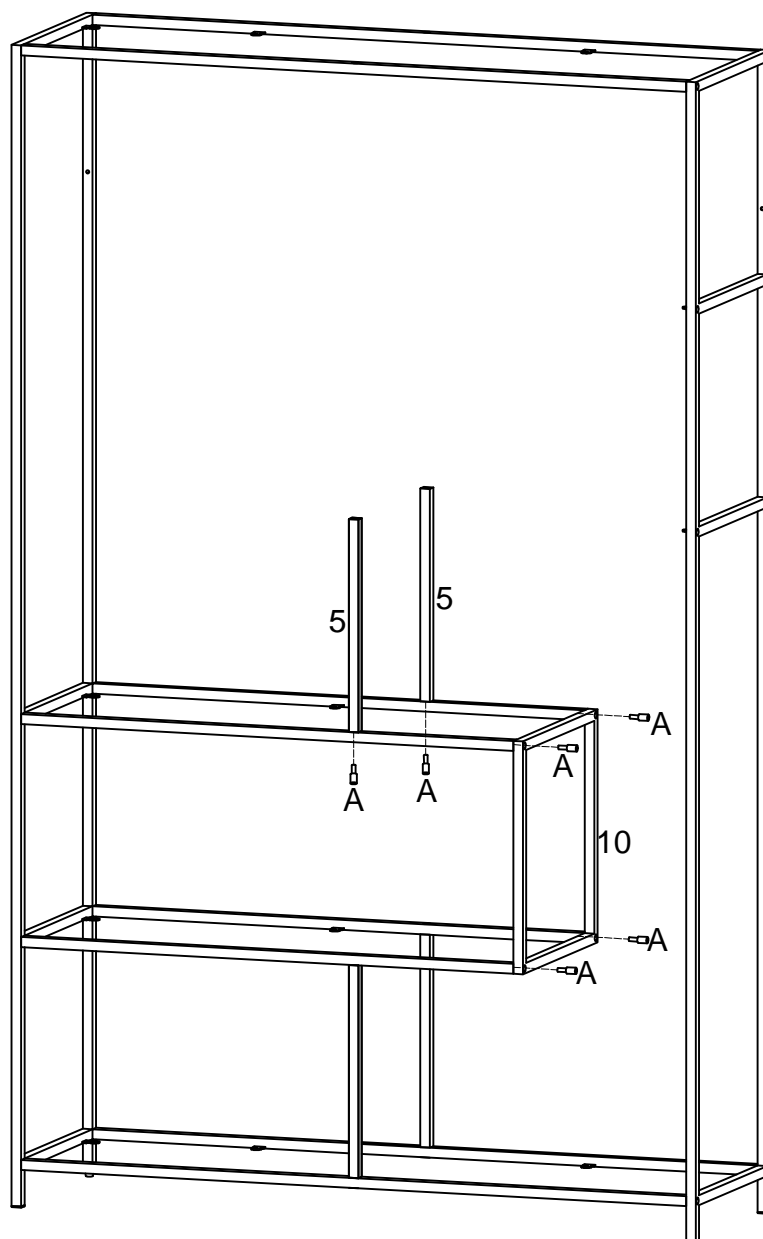
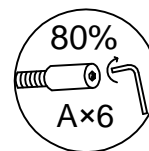

| | |
|--|---|
| A M6×15mm  6PCS | C 4mm  1PC |
|--|---|



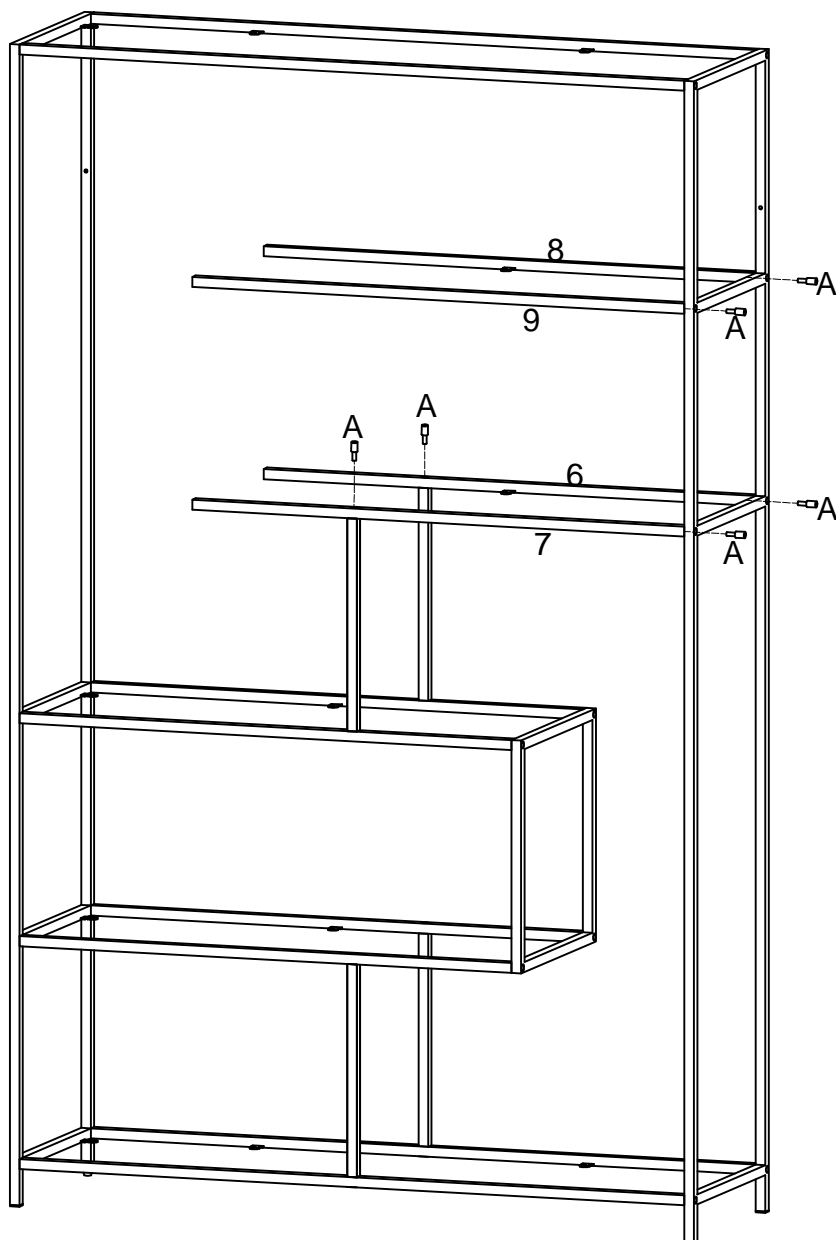
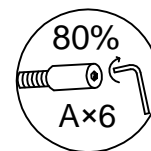

| | |
|--|---|
| A M6×15mm  6PCS | C 4mm  1PC |
|--|---|

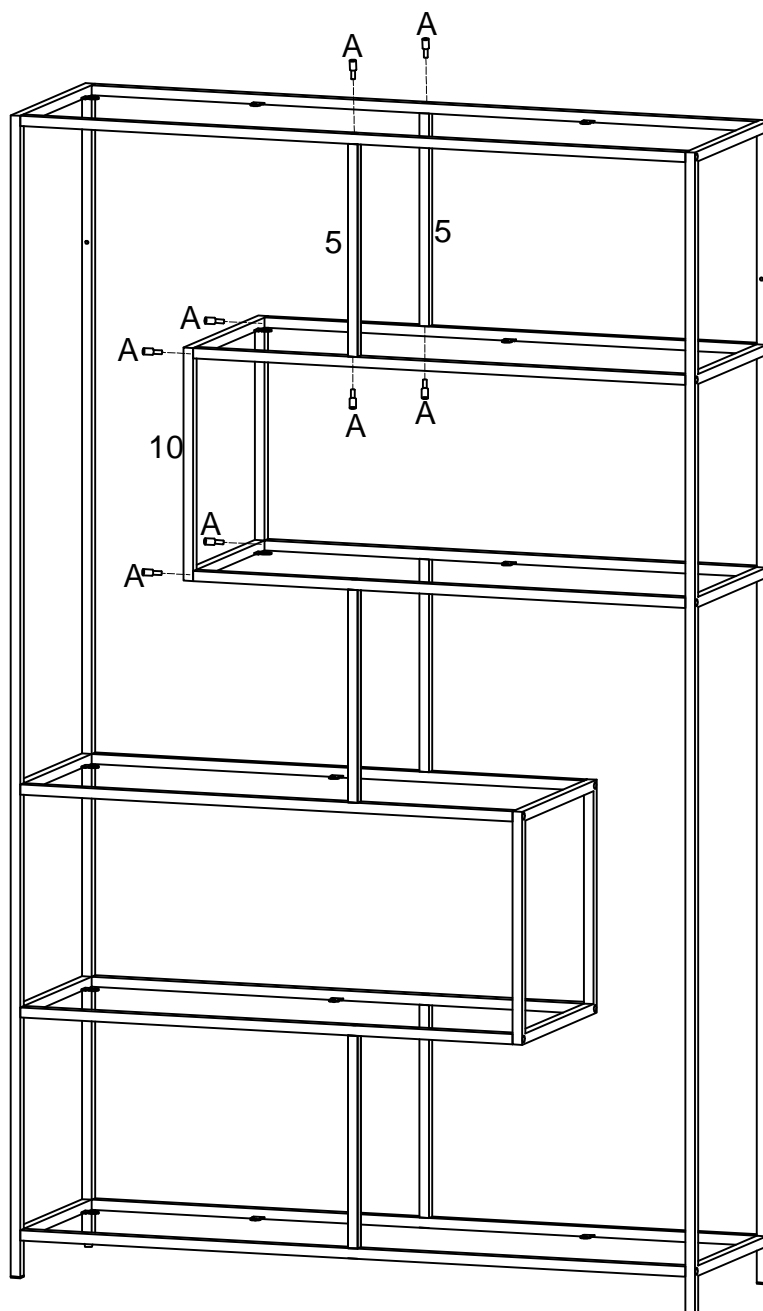
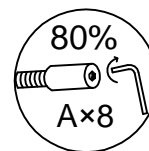

| | |
|--|---|
| A M6×15mm  6PCS | C 4mm  1PC |
|--|---|



| | |
|--|---|
| A M6×15mm  8PCS | C 4mm  1PC |
|--|---|

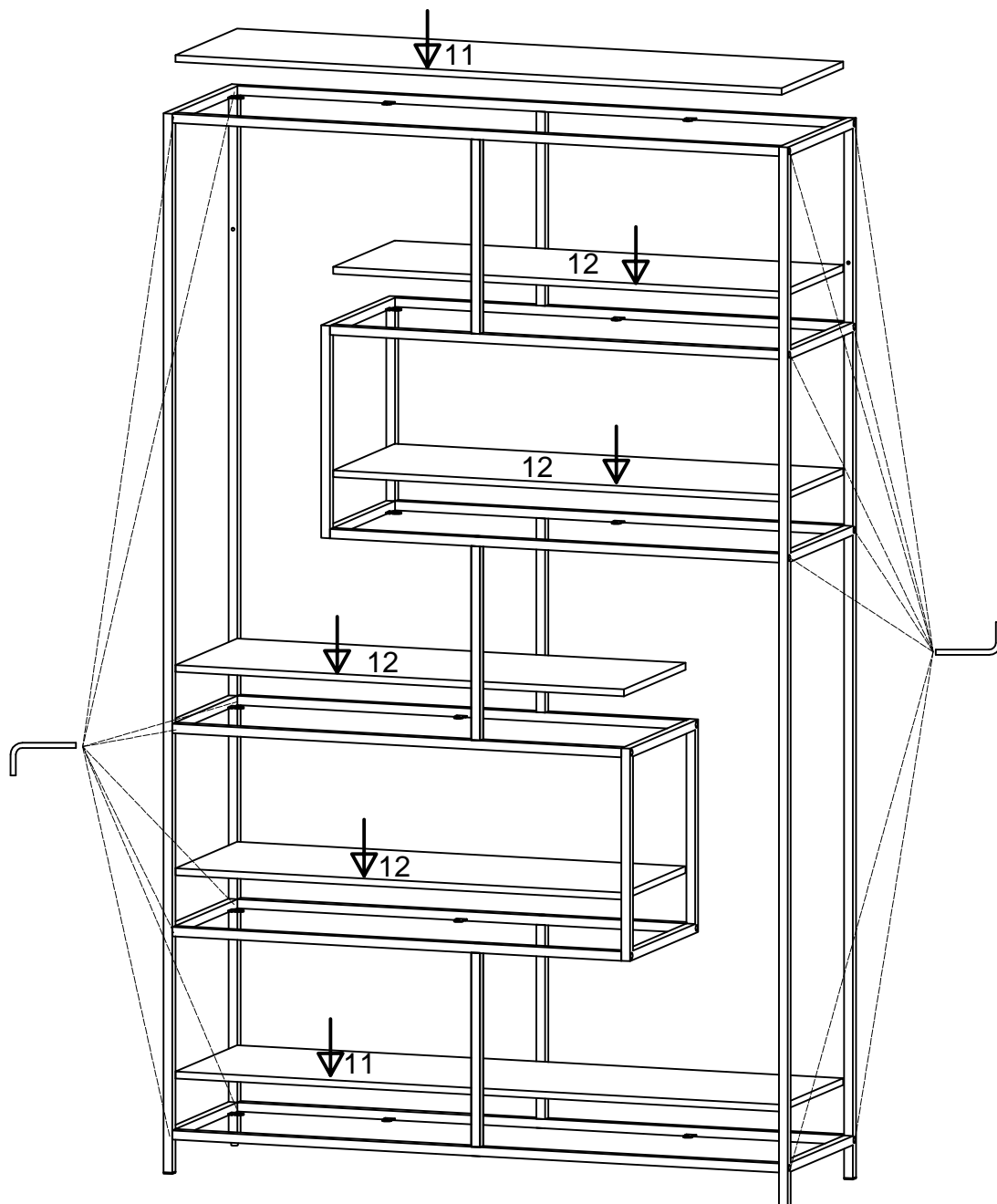
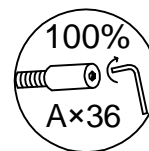

! XX=YY

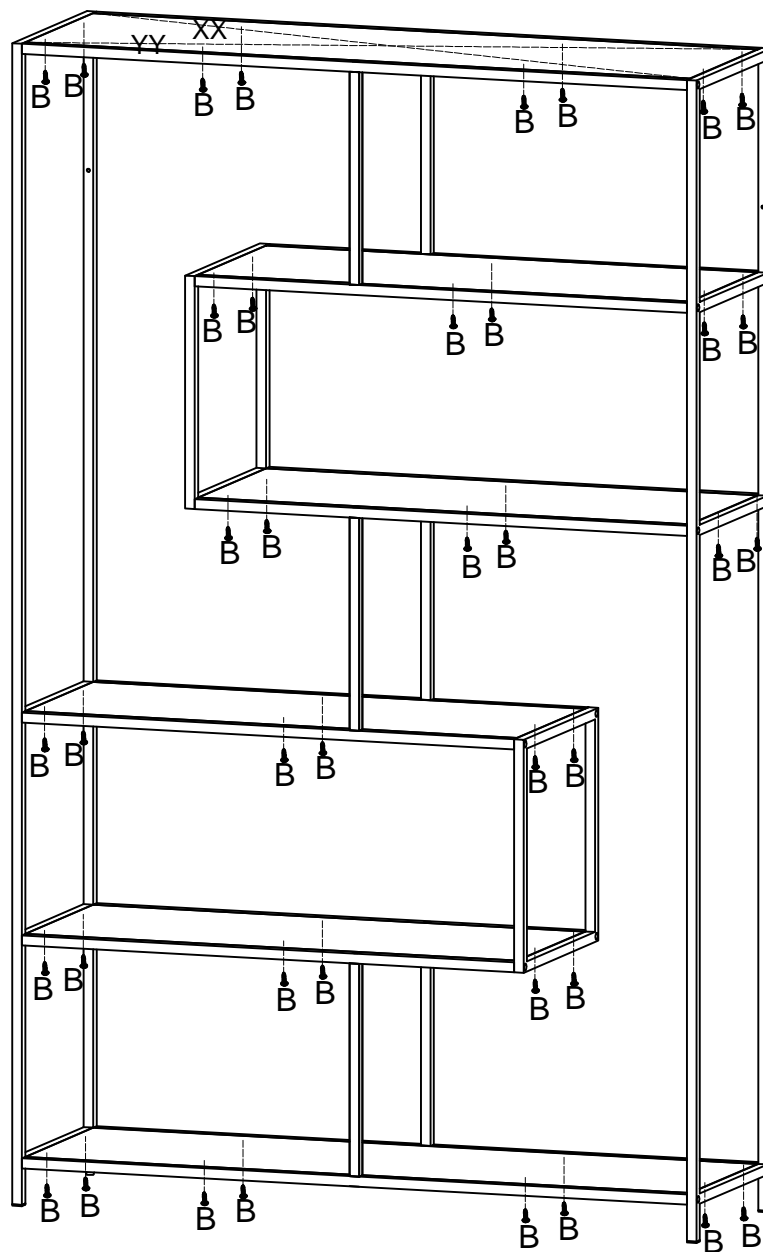
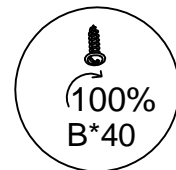

B
M4×10mm

40PCS

