









HARDWARE LIST

1		M8x60	08pcs	6		Anchors	02pcs
2		Ø8xØ12	08pcs	7		Metal Plate	02pcs
3		Ø8xØ16	08pcs	8		M4X50	02pcs
4		Ø8xØ19	08pcs	9		Drawstring	02pcs
5		Wrench	01pcs				



A x 1

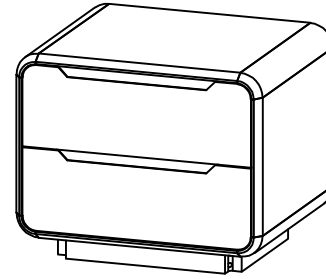
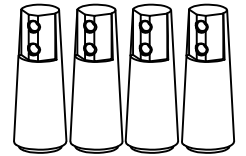

B x 4



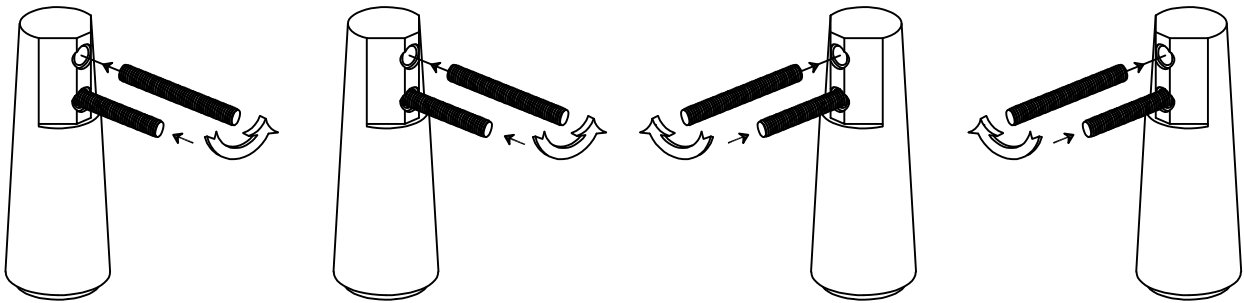



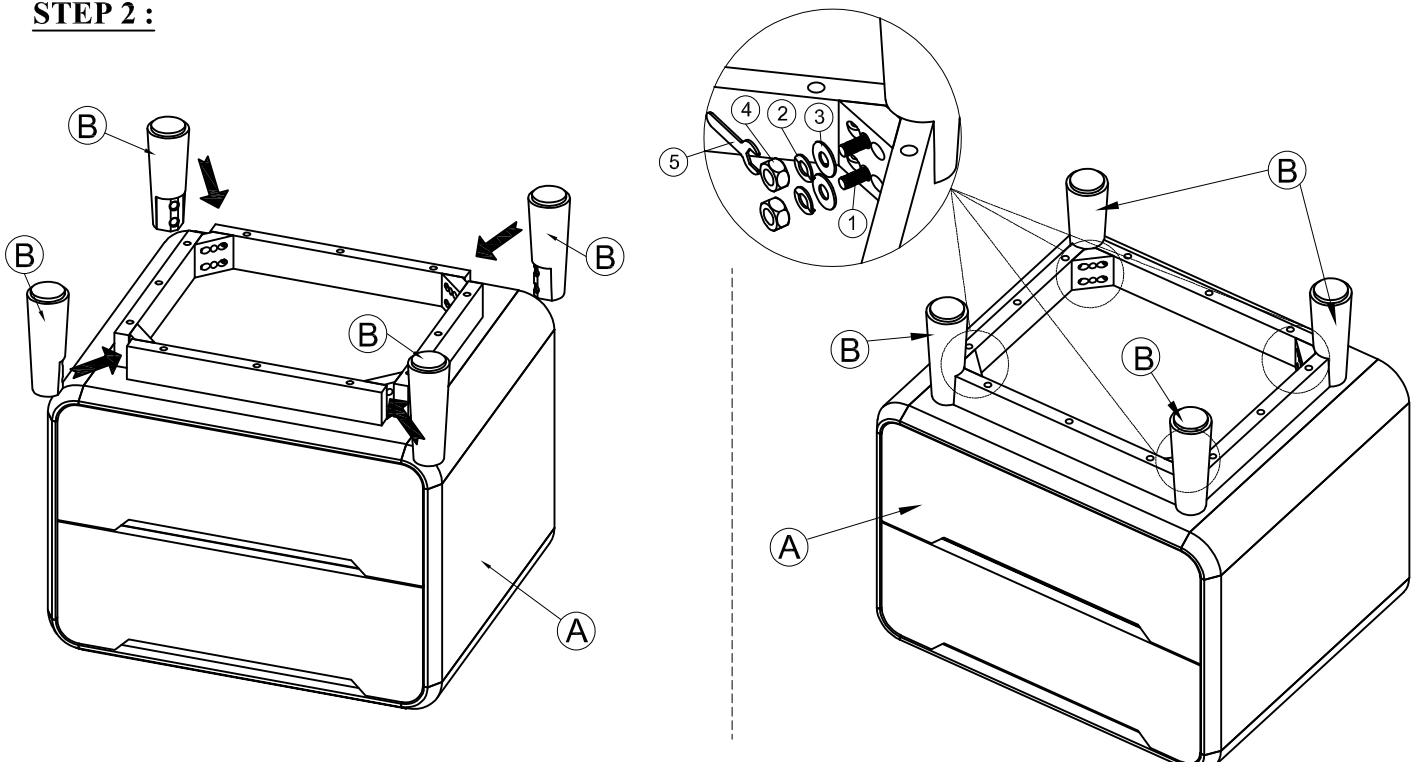

STEP 1 :



STEP 2 :



HARDWARE LIST

1		M8x60	08pcs	6		Anchors	02pcs
2		Ø8xØ12	08pcs	7		Metal Plate	02pcs
3		Ø8xØ16	08pcs	8		M4X50	02pcs
4		Ø8xØ19	08pcs	9		Drawstring	02pcs
5		Wrench	01pcs				

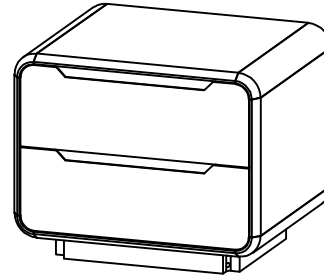

A x 1

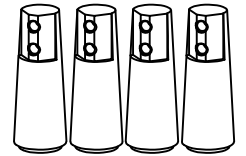

B x 4

STEP 3 :

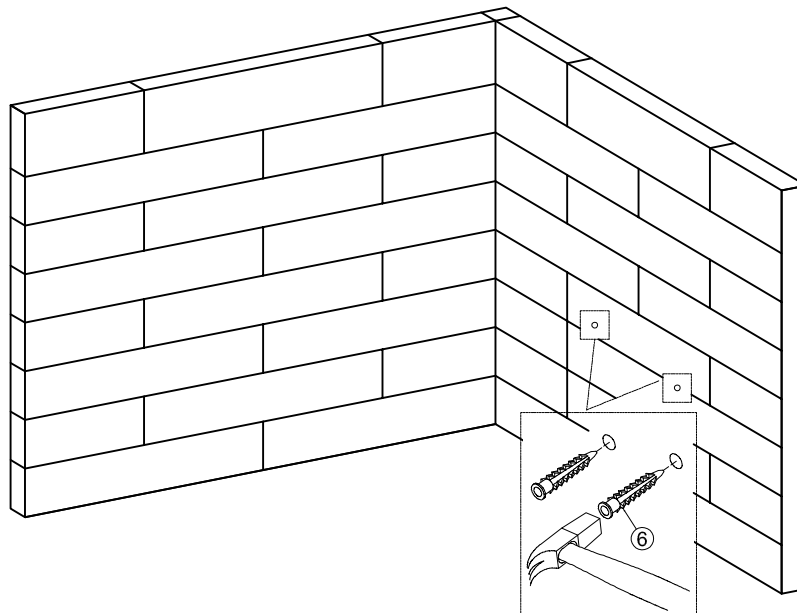



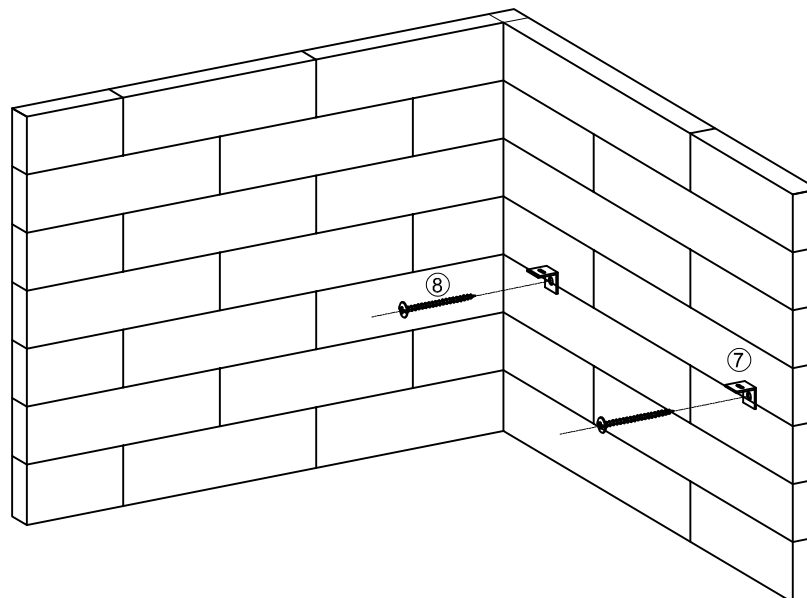





STEP 4 :



108773

Boston Side Table

HARDWARE LIST

1		M8x60	08pcs	6		Anchors	02pcs
2		Ø8xØ12	08pcs	7		Metal Plate	02pcs
3		Ø8xØ16	08pcs	8		M4X50	02pcs
4		Ø8xØ19	08pcs	9		Drawstring	02pcs
5		Wrench	01pcs				

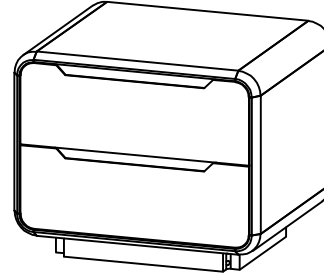

A x 1

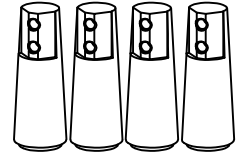

B x 4

STEP 5 :

